



Operation and Maintenance Manual for the
SODRTEK[®]
ST 145 Desoldering System
P/N 5050-0535



TITLE	PAGE
General Information	
Introduction.....	3
Specifications	3
Parts Identification.....	4
Safety	5
Safety Guidelines	5
System Set-Up	6
Tip & Tool Stand.....	6
Handpiece Connection	6
TEKLINK.....	6
System Power Up	7
Set-Up Mode	7
Introduction.....	8
Entering Set-Up Mode.....	8
Password.....	8
Temperature Scale.....	8
Temperature Limits	8
Offset Constant	9
Temperature Setback.....	9
Auto Off	10
Temperature Display Impedance	10
Exiting Set-Up Mode	10
Heater Burn In Procedure	10
Quick Start Procedure.....	11
Operation.....	13
Auto Tip Temperature Compensation and Offset	13
Password.....	13
LED Display Normal Operation	13
LED Display Temperature Adjust Mode.....	14
Vacuum Pump Operation	14
Handpiece Vacuum/Pressure.....	14
Temperature Setback Mode.....	16
Auto Off Safety System Mode.....	17
LED Display Accuracy.....	17
LED Message Codes	17
Corrective Maintenance	18
Power Source.....	18
Handpieces.....	18
Factory Settings	19
Definitions.....	19
Packing List.....	20
Spare Parts	20
Service	20
Limited Warranty Form.....	21
Contact Information.....	22

General Information

Introduction

Thank you for purchasing the PACE SODRTEK® model ST 145 Analog Desoldering System. This manual will provide you with the information necessary to properly set up, operate and maintain the ST 145.

The ST 145 system is available in either 115 VAC or 230 VAC versions, which incorporates a highly responsive SensaTemp (closed loop) control system providing up to 80 Watts of total power to a single output channel. The 230 VAC version system bears the CE Conformity Marking, which assures the user that it conforms to EMC 89/336/EEC.

The 115 VAC version systems conform to FCC Emission Control Standard, Title 47, Subpart B, Class A. This standard is designed to provide reasonable protection against harmful interference when the equipment is operated in a commercial environment.

Specifications

System Power Source Power Requirements

ST 145	Operates on 97-127 VAC, 50/60Hz, 120 Watts maximum at 115 VAC, 60Hz
ST 145E	Operates on 197-253 VAC 50/60Hz, 120 Watts maximum at 230 VAC, 50Hz

Temperature Specifications

Handpieces Tip Temperature Range: 204 to 455°C (400 to 850°F) nominal.
Temperature Stability: $\pm 1.1^{\circ}\text{C}$ ($\pm 2^{\circ}\text{F}$) at idle from set tip temp.

NOTE: Actual minimum and maximum Operating Tip Temperatures may vary depending on Handpiece, Tip Selection and application.

Vacuum And Air

Measurements at front panel Vacuum and Controllable Pressure Ports.
Vacuum Rise Time: ----- 150 ms average.
Vacuum: 51 cm Hg. (20 in. Hg.) (nominal)
Pressure: 1.44 Bar (21 P.S.I.) (nominal at MAX setting)
Air Flow: 6 SLPM (0.22 SCFM) maximum

EOS/ESD Specifications

The specifications shown below apply except on "Soft Ground Systems" which have a 1meg ohm current limiting resistance and a label placed on the power source front panel referring to EN 100015-1.

Tip-To-Ground Resistance: Less than 2 ohms.
AC Leakage: Less than 2 Millivolts RMS from 50Hz to 10MHz.
Transient Level: Less than 500mV peak, out to 100MHz.

Parts Identification

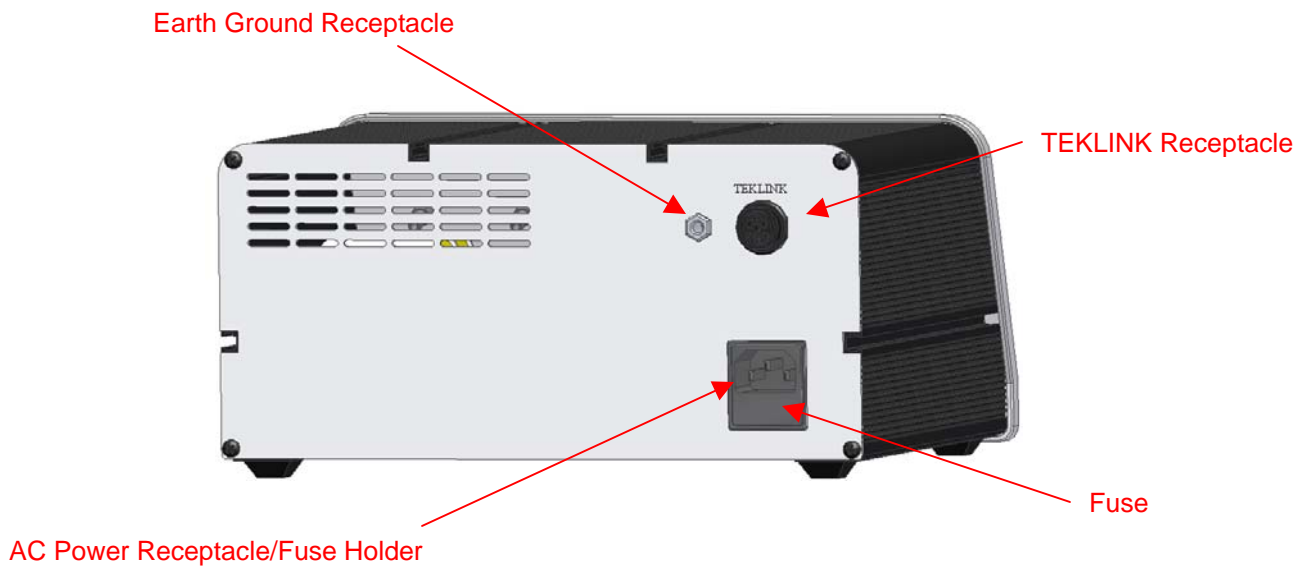
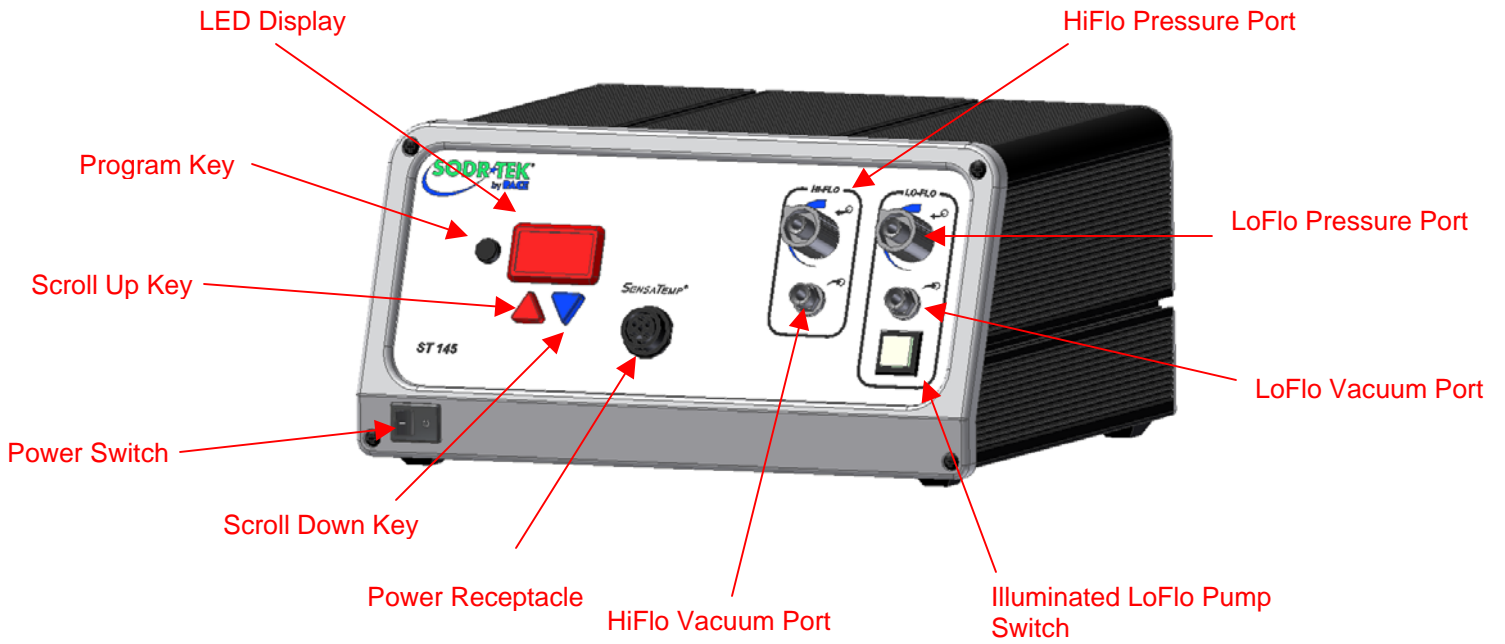

Safety

Safety Guidelines

The following are safety precautions that personnel must understand and follow when using or servicing this product.

1. **POTENTIAL SHOCK HAZARD** - Repair procedures on PACE products should be performed by Qualified Service Personnel only. Line voltage parts may be exposed when the equipment is disassembled. Service personnel must avoid contact with these parts when troubleshooting the product.
2. To prevent personnel injury, adhere to safety guidelines in accordance with OSHA and other applicable safety standards.
3. SensaTemp handpiece heaters and installed tips are hot when the handpiece is powered on and for a period of time after power off. **DO NOT** touch either the heater or the tip. Severe burns may result.
4. PACE Tip & Tool Stands and handpiece cubbies are designed specifically for use with the associated handpiece and houses it in a manner that protects the user from accidental burns. Always store the handpiece in its holder. Be sure to place the handpiece in its holder after use and allow for cooling before storing.
5. Always use PACE systems in a well ventilated area. A fume extraction system such as those available from PACE are highly recommended to help protect personnel from solder flux fumes.
6. Exercise proper precautions when using chemicals (e.g., solder paste). Refer to the Material Safety Data Sheet (MSDS) supplied with each chemical and adhere to all safety precautions recommended by the manufacturer.

System Set-Up

Set up the ST 145 system using the following steps and associated drawings.

1. Store the shipping container in a convenient location. Reuse of these containers will prevent damage if you store or ship your system.
2. Place the Power Switch in the "OFF" or "0" position.



Tip & Tool Stand

The Tip & Tool Stand can be mounted to the power source. If the system will be placed on the workbench, this is recommended. If the ST 145 is to be mounted under the workbench or shelf, the Tip & Tool Stand should not be mounted to the power source.

1. To attach the stand to the power source:
 - a) Insert the 2 Mounting Screws (head first) into the power source mounting slots (plastic case shown). Slide the screws toward rear of the power source.
 - b) Place the Tip & Tool Stand beside the power source. Insert ends of the 2 Mounting Screws into the 2 Tip & Tool Stand mounting holes as shown.
 - c) Install a Thumb Nut onto the end of each Mounting Screw and tighten Thumb Nuts.
2. Place the handpiece into its Tip & Tool Stand.

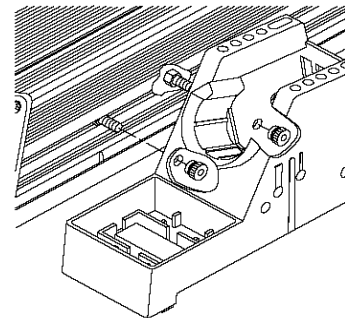

Handpiece Connection

Connect the handpiece connector plug into the Power Receptacle in the following manner.

1. Align guide on connector with slot on power receptacle.
2. Insert connector into power receptacle.
3. Turn the connector housing clockwise to lock in place.

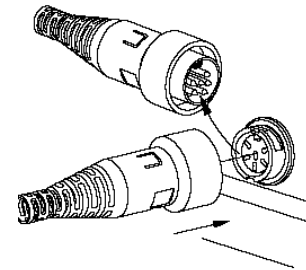

CAUTION: Ensure that only one air hose is connected to the **VACUUM** or controllable **PRESSURE** port at one time. Attachment to both ports simultaneously will cause deterioration in performance.

TEKLINK

The TEKLINK receptacle located on the back panel of the power supply allows you to interface the **VACUUM** and **PRESSURE** features of your ST 125/145 with the SODRTEK ST 25/45 system. This feature gives you the freedom to operate air-controlled handpieces (SX-70/80, TP-65, or TJ-70/80) from an ST 25/45 system through the **VACUUM** and **PRESSURE** ports of your ST 125/145. To link your ST 125/145 system to the ST 25/45 system, perform the following procedure.

TEKLINK Receptacle

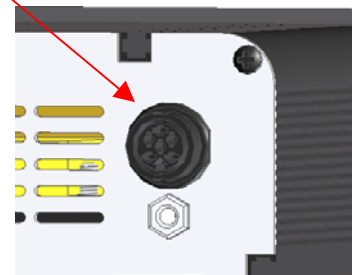

1. Place the ST 25/45 system adjacent to (side by side) or stacked on top of your ST 125/145 system.
2. Use the TEKLINK cable (sold separately) to connect the systems together. The TEKLINK Receptacle is located on the back panel of each power supply.
3. Ensure the VisiFilter assembly is connected to either the ST 125/145 **VACUUM** Port.
4. Connect the air hose of the handpiece being used, to either the VisiFilter assembly or the controllable **PRESSURE** port.

The TEKLINK Remote Box (sold separately) allows the connection of up to three ST 25/45 systems in any combination.

NOTE: Systems connected together through the TEKLINK system must be used and controlled by a single operator. Any attempt to operate by more than one individual can create a hazardous condition and will cause deterioration in performance.

System Power Up

1. Insert the female end of the power cord into the AC Power Receptacle on the rear panel of the power source.
2. Plug the prong end (male end) of the power cord into an appropriate 3 wire grounded AC supply receptacle.

CAUTION: To insure operator and ESD/EOS safety, the AC power supply receptacle must be checked for proper grounding before initial operation.

Set-Up Mode

PACE recommends that you not read the "Set-Up Mode" section until after you feel comfortable with system operation. Please read the following "Operation" section thoroughly before changing the system settings.



Introduction

The menu driven LED Display of the ST 145 system in the Set-Up Mode allows you to easily customize your system. No calibration adjustments are necessary to maintain the accuracy of the system. In Set-Up Mode, you can:

1. Enter, remove or change a Password.
2. Set the Default Temperature scale to °F or °C as desired.
3. Change the Upper and Lower Temperature limits.
4. Enter a Temperature Offset Constant (Auto Tip Temperature Compensation).
5. Enable or disable the Temperature Setback feature and adjust the timeout period (if enabled).
6. Enable or disable the Auto Off feature and adjust the time-out period (if enabled).



7. Enable or disable the Average Temperature feature. The following instructions should be performed to familiarize the operator with the system.

Entering Set-Up Mode

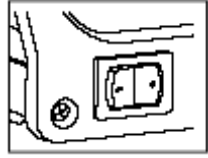
1. Place Power Switch in the "OFF" ("0") position.
2. Press and hold the Program () Key.
3. Place Power Switch in the "ON" ("1") position. Release the Program () Key.



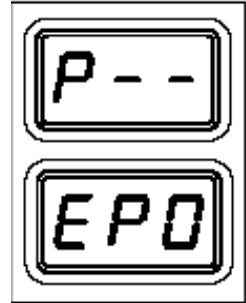

Password

4. The LED Display will display the version of the microprocessor and change to read "P--" or "EP0".
5. If the display reads "EP0", a Password has been stored in system memory. Enter the 5 key sequence Password. If the Password entered is incorrect, "no" appears on the display and the system then returns to normal operation. If this occurs, repeat steps 1 through 5 and enter the correct Password.
6. The LED Display reads "P- -". Choose one of the following options:
 - a) Press the Program () Key to keep the currently stored Password (including no Password).
 - b) Press and release the Scroll Up () Key to enter a new Password.
 - c) Press and release the Scroll Down () Key if you wish to remove a stored password or do not wish to store a Password.
7. If the LED Display now reads "EP0", select and enter a 5 key password sequence. Make a note of the entered Password. As the Password is entered, the last digit of the display will count up with each key entry. After the fifth key entry, proceed to step 8.





Temperature Scale

8. The LED Display now shows the stored default Temperature Scale (°C or °F temperature shown on LED Display). Choose one of the following:
 - a) Press the Program () Key to keep the stored default Temperature Scale.
 - b) Press and release the Scroll Up () Key to change the default Temperature Scale. Press and release the Program () Key.



Temperature Limits

9. The LED Display now shows the stored default High ("Hi") Temperature Limit with the display alternating to show "Hi" and the stored limit. Choose one of the following:
 - a) Press and release the Program () Key to keep the stored High Temperature Limit.
 - b) Press and release the Scroll Up () Key to increase the stored High

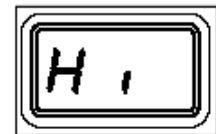



Temperature Limit (up to 482°C, 900°F). Press and release the Program Key to proceed to the next step.

- c) Press and release the Scroll Down (▼) Key to decrease the stored High Temperature Limit. Press and release the Program () Key to proceed to the next step.

10. The LED Display now shows the stored default Low ("Lo") Temperature Limit with the display alternating to show "Lo" and the stored limit. Choose one of the following:





- a) Press and release the Program () Key to keep the stored Low Temperature Limit (204°C, 400°F min.).
- b) Press and release the Scroll Up (▲) Key to increase the stored Low Temperature Limit. Press and release the Program () Key to proceed to the next step.
- c) Press and release the Scroll Down (▼) Key to decrease the stored Low Temperature Limit. Press and release the Program () Key to proceed to the next step.

Offset Constant

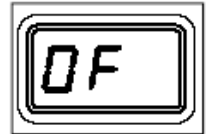
11. The LED Display now shows the stored Offset Constant with the display alternating to show "OF" and the stored Offset Constant. Choose one of the following:







- a) Press and release the Program () Key to keep the currently stored Offset Constant.
- b) Press and release the Scroll Up (▲) Key to increase the stored Offset Constant. An Offset Constant of 0-133°C (0-240°F) can be stored. Press and release the Program () Key to proceed to the next step.
- c) Press and release the Scroll Down (▼) Key to decrease the stored Offset Constant. Press and release the Program () Key to proceed to the next step.

NOTE: If the attached handpiece is disconnected when the system is powered up, any stored Offset Constant is reset to zero. The Offset Constant must be entered again in the Set-Up Mode.

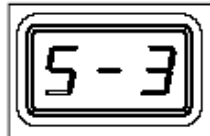
Temperature Setback

12. The LED Display now shows the stored Temperature Setback time as "S-X" (x=0 thru9). Time is shown as tens of minutes (e.g., "S-3" equals 30 minutes). A display of "S- 0" indicates that Setback is disabled. Choose one of the following:







- a) Press and release the Program () Key to keep the currently stored Temperature Setback time.
- b) Press and release the Scroll Up (▲) Key to enable and/or increase the stored Temperature Setback time. Press and release the Program () Key to proceed to the next step.
- c) Press and release the Scroll Down (▼) Key to decrease or disable the stored Temperature Setback time. Press and release the Program () Key to proceed to the next step.

Auto Off

13. The LED Display now shows the stored Auto Off time as "AOx" (x=0 thru 9). Time is shown as tens of minutes (e.g., "AO3" equals 30 minutes). A display of "AO0" indicates that Auto Off is disabled. Choose one of the following:





- Press and release the Program () Key to keep the currently stored Auto Off time.
- Press and release the Scroll Up () Key to enable and/or increase the Auto Off. Press and release the Program () Key to proceed to the next step.
- Press and release the Scroll Down () Key to decrease or disable the stored Auto Off time. Press and release the Program () Key to proceed to the next step.

Temperature Display Impedance

14. The LED Display now shows the Temperature Display Impedance mode as Enabled or Disabled ("AC0" = Disabled and "AC1" = Enabled). Choose one of the following:





- Press and release the Program () Key to keep the currently stored setting (Disabled or Enabled).
- Press and release the Scroll Up Key to change the stored setting (Disabled or Enabled). Press and release the Program () Key to proceed to the next step.

Exiting Set-Up Mode

15. The LED Display now reads "End". The Set-Up Mode procedure is now complete. Choose one of the following steps:





- Press and release the Scroll Up () Key to exit Set-Up Mode and return to normal operation.
- Press and release the Scroll Down () Key to return to the start of the Set-Up Mode procedure.

Heater Burn In Procedure

Use the following instructions to perform the Heater Burn In procedure.

NOTE: Ensure that the system is placed in a well-ventilated area. Smoke will be generated during the burn in cycle and while soldering. Fume extraction equipment is recommended.

- Place the Power Switch in the "OFF" (0) position.
- Ensure that the handpiece is connected to the power source. If a plastic cap is present on the heater assembly, remove it and discard. The cap is used for shipping purposes only.
- Press and hold the Program () and Scroll Up () keys together.
- Place Power Switch in "ON" (I) position.

5. The display will read “brn” when the Program (°F) and Scroll Up(▲) keys are released.



6. Press the Scroll Up(▲) Key to initiate the Burn In Mode. The handpiece heater will begin to heat. The temperature of the heater will stabilize at 315°C (600 °F) for 10 minutes.

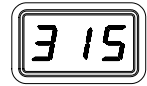

7. At the conclusion of the 10-minute period, the heater temperature will increase to 427°C (800°F) for 15 minutes.



8. At the conclusion of the 15-minute time period, the heater is turned off and the Display will read “End”. Press and release the Scroll Up Key(▲) to exit Heater Burn In and return the to normal operation.

CAUTION: The heater will be hot at the conclusion of the Burn In procedure.

NOTE: The microprocessor circuitry within the unit monitors the system to ensure proper results. If any abnormalities are encountered, the Burn In cycle will be interrupted and an error message displayed. If this situation should occur, turn the system off and perform the procedure again. If the cycle is interrupted a second time, refer to the Corrective Maintenance section and check for handpiece malfunction information. If a second handpiece is available, perform the procedure using that handpiece.

This procedure should be performed whenever a new handpiece or new heater is connected to the system. Ensure that the system is placed in a well-ventilated area. Smoke will be generated during the burn in cycle and while soldering. Fume extraction equipment is recommended.

Quick Start Procedure

The ST 145 system is very easy to operate. As received from the factory, the system can be quickly set up for use in standard desoldering/soldering operations. Simply perform the following Quick Start Procedure to begin system operation.

1. Ensure that the Set-Up procedure has been performed; including the Heater Burn In procedure. Check for the following:
 - a) Handpiece connections (connector plug and air hose) to the power source.
 - b) Proper tip installed in handpiece.
 - c) Power cord connection between house AC supply receptacle and the power source.
 - d) House air supply connection to power supply.
2. Turn the Power Switch “On” (“I”).
3. Press the Scroll Up(▲) Key. The Set Temperature is now displayed. If no other Key is pressed within 5 seconds, the system will revert to normal operation. Allow time for the system to change back.
4. Press the Scroll Up(▲) Key. The Set Temperature is now displayed; immediately perform step 5.
5. Adjust the Set Temperature in the following manner:



- a) Press and release the Scroll Up (▲) Key to increase Tip Temperature in increments. Press and release the Scroll Down (▼) Key to decrease Tip Temperature. Observe the display as the Set Temperature increases in increments of 1°.

NOTE: If a Password has been previously programmed into the system, "EP0" will appear on the LED Display at this point. When this message appears, the operator must enter the correct 5 key Password before adjusting the temperature. Refer to "Password" in the "Operation" portion of this manual.

- b) Adjust the temperature by pressing and holding Scroll Up (▲) Key. Observe the display as the Set Temperature increases first in increments of 1° and then in increments of 10°. Release the key.
- c) Using the Scroll Keys, adjust the temperature to any standard operating temperature used by your company.

NOTE: The Set Temperature can only be within the set temperature limits. If a limit (upper or lower) is reached, the lower limit would display "OFF"; the upper limit would not allow the Set Temperature to exceed that limit. Temperature limits can be adjusted in the Set-Up Mode.

6. Press the Program Key (). The system will now return to normal operation.
7. Observe the Digital Readout as the temperature stabilizes at the desired Set Tip Temperature.
8. Manually force the system into Temperature Setback in the following manner:
 - a) Press and hold the Scroll Down (▼) Key and the Scroll Up (▲) Key.
 - b) Release both keys.
9. The system is now in Temperature Setback. Observe the flashing of the LED Display and the decreasing of the tip temperature. Allow time for the temperature to stabilize at 177°C (350°F).

NOTE: If Auto Off has been enabled (turned on in Set-Up Mode), the system will enter Auto Off (temperature Off and LED Display flashing "Off") after the preset time of handpiece inactivity. Auto Off can be exited by pressing any key.

10. Manually force the system out of Temperature Setback in either of the following manners:
 - a) Press and release a Key (either of the 3 keys). This is the preferred method.
 - b) Wipe the hot handpiece tip on a wet sponge to lower the tip temperature.
 - c) Turn the Power Switch Off ("0") and then back on ("I").
11. The system is now in normal operation. Observe the LED Display as the tip temperature increases to the Set Temperature. Allow time for the temperature to stabilize at the Set Temperature.

NOTE: Read the "Operation" and "Set-Up Mode" sections of this manual to utilize the full capabilities of the system. This is especially important when using large soldering tips or other SensaTemp handpieces.

12. If you have a Sodr-X-Tractor or other PACE air handpiece connected to your system, press and hold the handpiece Vacuum Switch. You will hear a noise as the motor pump starts up and continues to run. Release the Vacuum Switch.

Operation

Auto Tip Temperature Compensation and Offset

Differences between the temperature settings and true tip temperatures are negligible when using Thru-Hole, single point desoldering tips. With any heating system however, True Tip Temperatures can differ greatly from temperature settings when using larger SMT soldering tips. This difference is called Tip Temperature Offset. The ST 145 Auto Tip Temperature Compensation feature lets you set and display true tip temperatures regardless of size and type of tip or handpiece. PACE recommends the use of the Tip & Temperature Selection System booklet (PACE P/N 5050-0251) as a guide to accurately set and maintain a true tip temperature for any size and type of SMT tip. The booklet contains a listing of PACE tip information including the Tip Offset Constant (for each tip), which must be stored in system memory to ensure tip temperature accuracy. Refer to the "Set-Up Mode" section of this manual for instructions on using this feature.

As with any system, Set and Operating Tip Temperatures are only exactly equal when the handpiece is idling (unloaded at equilibrium). During use, (i.e., under load) the Operating Tip Temperature will usually be lower.

Password

The Password feature of the ST 145 system, when activated, will prevent unauthorized alteration of stored system temperature parameters and feature settings (refer to the "Factory Settings"). If a Password has been installed, the LED Display will display an instruction to enter the Password (a 5 key sequence of the keys on the system front panel) when a setting change is attempted. Entry of the correct Password at this point will allow the operator to proceed with the desired changes. Once the correct Password has been entered, the operator can continue to make changes to Tip Temperature settings. To reactivate the Password protection, simply turn the system Power Switch off and then back on. The system is now in normal operation. Refer to the "Set-Up Mode" section of this manual for instructions on entering, changing or removing a Password.

LED Display, Normal Operation

The LED Display provides a 3 digit display of temperature information. The LED Display will show:

1. A display of "888" on power up to ensure that all LEDs on the display are working.
2. A display of the software version of the installed microprocessor (e.g., "1-1") for 2 seconds on initial power up after the "888" is displayed.
3. Actual tip temperature of the connected handpiece during normal operation.
4. The tip temperature displayed will flash when the system is in Temperature Setback.

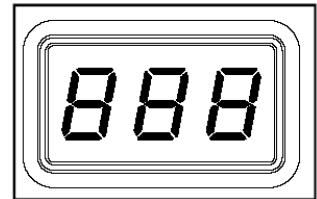

5. The displayed temperature will decrease and stabilize at 177°C (350°F) when the system is in Temperature Setback.
6. "OFF" when the Set Tip Temperature has been set to Off (below minimum set tip temperature). Refer to the "Set-Up Mode" portion of this manual.
7. "OFF" plus the LED Display will be flashing when the unit has entered Auto Off. Refer to the "Set-Up Mode" portion of this manual.
8. Error messages ("OSE", "SSE" or "OCE") if a system fault is detected. Refer to the "Corrective Maintenance" portion of this manual.

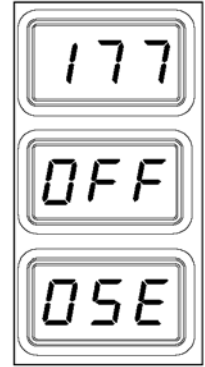

LED Display, Temperature Adjust Mode

The LED Display will show the following when adjusting the desired Set Tip Temperature.

1. The Set Tip Temperature.
2. "HiL" (High Temperature Limit) when adjusting the set tip temperature and the maximum allowable temperature is exceeded. Refer to the "Set-Up Mode" portion of this manual.
3. "OFF" (Low Temperature Limit) when adjusting the set tip temperature and the minimum allowable temperature is exceeded. Refer to the "Set-Up Mode" portion of this manual.
4. "EPO" will be displayed if a Set Tip Temperature adjustment is attempted and a Password has been stored in system memory. As the 5 key Password is entered, the zero will increase by one as each key entry is made. Upon entry of the fifth password key, the display will change to the Set Tip Temperature if the entered Password matches the stored Password.
5. "no" will be displayed if the entered password does not match the stored Password.

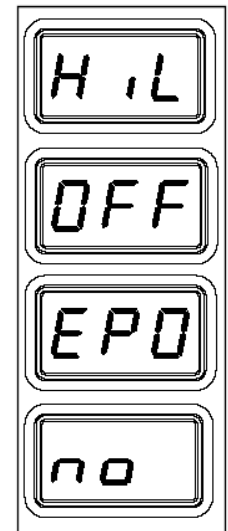

Vacuum Pump Operation

The PACE ST 145 contains two different vacuum pumps.

1. HiFlo Pump
 - a) To activate, depress the handpiece activation button.
 - b) Optional Foot Pedal can be used to actuate the HiFlo pump via the rear TEKLINK socket.
2. LoFlo Pump
 - a) This pump is activated by the front Illuminated LoFlo Pump Switch.
 - b) For use with the TJ-80 and PV-65 Pik Vac Wand.

Handpiece Vacuum/Pressure

To set up your Sodr-X-Tractor air hose connection, perform the following steps:

1. Air Hose To Handpiece Connection

- a) Attach one end of a 137cm (54 inch) length of air hose to the metal tube in the back of the handpiece.
- b) If you have a PACE system incorporating only one handpiece, attach the air hose to the power cable using the supplied Hose Clamps. Space them evenly along the length of the power cable starting at a point 6 inches from the ends of the handpiece.
- c) If you have a PACE system incorporating 2 or more air handpieces, you may wish to leave the air hose assembly unattached to allow a quick change to any air handpiece being used.

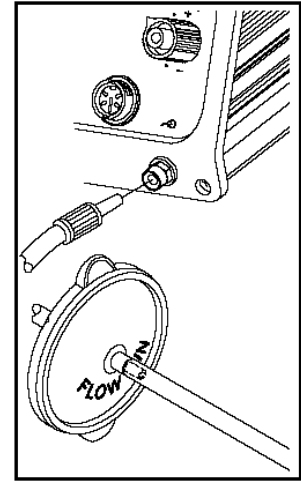

2. Prepare a VisiFilter in the following manner:

- a) Connect a 1 inch (2.5cm) length of clear pvc air hose to the FLOW OUT side of the VisiFilter; push and turn the hose onto the VisiFilter nipple to seat.
- b) Insert the ribbed end of a male quick connect hose mount fitting (P/N 1259-0087) into the free end of the 1 inch (2.5cm) length of air hose connected to the FLOW OUT side of the VisiFilter.
- c) Connect the free end of the 137cm (54 inch) length of air hose to the FLOW IN side of the VisiFilter.
- d) Insert the end of the quick connect hose mount fitting (on VisiFilter FLOW OUT side) into the power source Vacuum Port.

3. When using air pressure, and/or utilizing multiple air handpieces, PACE recommends the use of the following set up procedure which utilizes additional quick connect hose mount fittings. An assortment of quick connect air fittings are supplied with each additional air handpiece.

- a) Disconnect the 137cm (54 inch) length of air hose from the FLOW IN side of the VisiFilter assembly. Insert the ribbed end of a male quick connect hose mount fitting (P/N 1259-0087) into the free end of this air hose.
- b) Connect the free end of a 1 inch (2.5cm) length of air hose with an installed female quick connect hose mount fitting (P/N 1259-0086) to the FLOW IN side of the VisiFilter Assembly.
- c) The 137cm (54 inch) length of air hose can now be easily moved between the VisiFilter Assembly and the Controllable Pressure Port. The VisiFilter assembly remains connected to the Vacuum Port.

4. Additional fittings may also be added to the hose connection at the rear of each air handpiece to ease changing of handpieces.

NOTE: When removing any air hose, turn and pull. Do not attempt to pull hose directly off. Damage to or breakage of fitting or VisiFilter may occur. Use your Sodr-X-Tractor with a clean VisiFilter element. Otherwise a deterioration in performance or damage to the unit may occur.

Temperature Setback Mode

To preserve tip life and save energy, the ST 145 system can be programmed to automatically set back its Tip Temperature to 177°C (350°F) after a selected period of handpiece inactivity (adjustable 10-90 minutes in Set-Up Mode). As received from the factory, this feature is enabled. Refer to the “Set-Up Mode” section of this manual to disable or adjust the time-out period of this feature. The operator can also force the system into Temperature Setback.

Activation

There are two ways in which the system will activate the Temperature Setback feature.

1. AUTOMATIC ACTIVATION – The system memory can be programmed so that the system will automatically activate Temperature Setback after a selected period (10-90 minutes) of handpiece inactivity. See the “Set-Up Mode” section for details on programming this feature.
2. MANUAL ACTIVATION – The operator can manually force the system to place the system in Temperature Setback by performing the following procedure.
 - a) Press and hold the Scroll Down (▼) Key.
 - b) Press the Scroll Up (▲) Key.
 - c) Release both keys.

Operation

Temperature Setback is indicated by the following.

1. The LED Display will be flashing
2. The Operating Temperature will stabilize at 177°C (350°F).

Exiting Temperature Setback

Listed below are 3 different ways to exit Temperature Setback.

1. Press and release either Scroll Key (▲) or (▼). This is the preferred method.
2. Wipe the hot handpiece tip on a wet sponge to lower the tip temperature.
3. Method “1” is preferred but you can turn the Power Switch “OFF” (“0”) and then back “ON” (“1”).

Set Tip Temperature and Tip Offset Constant values will be simultaneously restored. Observe the LED Display as the Operating Tip Temperature stabilizes at the Set Tip Temperature. For optimum performance, do not attempt to use the attached handpiece until the Set Tip Temperature is achieved.

Auto Off Safety System Mode

When enabled, the Auto Off safety system of the ST 145 system removes power 10-90 minutes (enabled/disabled and adjustable in Set-Up Mode) after entering Temperature Setback.

When the system has entered Temperature SetBack, an Auto Off timer within the system circuitry will start running (if Auto Off is turned on in Set-Up Mode):

1. If any key is pressed during the selected time out period, the Auto Off timer is reset. The system will return to normal operation.
2. At the end of the time out period, the system will enter Auto Off. Power is removed, the LED Display will show "OFF " and the display will be flashing.

Exiting Auto Off

Auto Off can be exited; returning to normal operation by:





1. Pressing and releasing a Key (either of the 3 keys).
- OR**
2. By turning the Power Switch OFF ("0") and then back ON ("1").

LED Display Accuracy

No adjustments are necessary to maintain the accuracy of the system.

LED Display Message Codes

Following LED Display message codes which may appear if a mistake is made by the operator (e.g., wrong Password entry) or if the system has malfunctioned.

LED Display Message	Description
	The incorrect Password has been entered. The displayed message will time out after 6 seconds and revert back to normal operation. Enter the Password.
 The LED Display is flashing.	No handpiece is connected to the Power Receptacle. Connect the handpiece. The handpiece heater assembly sensor is open. Refer to the respective handpiece manual.
 The LED Display is flashing.	The handpiece heater assembly is shorted. Refer to the respective handpiece manual.
 The LED Display is flashing.	The handpiece heater assembly may be defective. Refer to the respective handpiece manual. Power source malfunction. Contact the PACE Service Department for assistance.

Corrective Maintenance

Power Source

Refer to the table below. Most malfunctions are simple and easy to correct.

Symptom	Probable Cause	Solution
No power to system.	Blown Fuse	Check handpiece using "Heater Assembly Checkout Procedures" in the respective handpiece manual. Replace the fuse (located in the AC Receptacle Fuse Holder) with one of the same rated value.
	Power Source Malfunction	Contact the PACE Service Department for assistance.
Insufficient vacuum or air pressure. Motor Pump runs.	Handpiece air hose has a kink or a hole in the hose.	Check handpiece hose. Replace air hose if necessary
	VisiFilter or handpiece filter clogged.	Replace VisiFilter or handpiece filter.
	Handpiece chamber not seated properly in handpiece.	Check handpiece. Reseat chamber if necessary.
	Defective Motor Pump Assembly.	Check vacuum and air pressure at Motor Pump Assembly air hose connections. Replace Motor Pump Assembly if necessary.
No vacuum or air pressure. Motor Pump does not run.	Defective handpiece.	Check handpiece using "Heater Assembly Checkout Procedures", in the respective handpiece manual.
	Defective Motor Pump Assembly.	Check for 12 VDC at motor terminals with handpiece switch actuated. Replace Motor Pump Assembly if defective.
	Defective Main PCB Assembly	If there is no 12 VDC at Motor Pump Assembly, repair or replace Main PCB Assembly.
Handpiece will not heat	Defective Handpiece Heater	Check handpiece using "Heater Assembly Checkout Procedures" in the respective handpiece manual.
	Power Source Malfunction	Contact the PACE Service Department for assistance.

Handpieces

Please refer to the specific handpiece manual for the "Heater Assembly Checkout Procedures."

Factory Settings

The ST 145 system comes equipped with a number of features which may be adjusted, enabled or disabled as desired by the user. Listed below are the features and factory settings of each. To change and/or learn about any of these features, refer to the applicable part of the "Set-Up Mode" portion of this manual.

FEATURE	FACTORY SETTING
Password	None Entered
Default Temperature Scale (°C/°F)	°F for 115V Systems °C for 230V Systems
"Hi L" (upper) Temperature Limit	482°C (900°F)
"LO" (lower) Temperature Limit	204°C (400°F)
Set Temperature	"OFF"
Tip Offset Constant	"0"
Temperature Setback	Enabled
Setback Time	30 Minutes
Auto Off	Enabled
Time To Auto Off	30 Minutes

Definitions

Please read and become familiar with the definitions of each of the following terms which are used repeatedly in the following operational procedures.

AUTO OFF - Safety feature which turns power off (10-90 minutes, settable in 10 minute increments) after the system has entered Temperature Setback.

NORMAL OPERATION - Normal operating mode of the system in which the Operating Tip Temperature is displayed.

OPERATING TIP TEMPERATURE - The true tip temperature at which the handpiece tip operates at any given time.

SET TIP TEMPERATURE - The operator selected idle tip temperature entered into the system memory.

SET-UP MODE - Mode of operation in which the operator can quickly and easily adjust the system parameters (e.g., temperature limits, password, setback time).

TEMPERATURE ADJUST MODE - Mode of operation in which the operator can quickly and easily adjust the Set Tip Temperature.

TEMPERATURE DISPLAY IMPEDANCE (TDI) MODE - Stabilizes the tip temperature shown on the LED Display by ignoring minor temperature fluctuations. Displayed changes in temperature are delayed (impeded) for two seconds when a load is applied to the tip. Two seconds after the load is removed, the displayed temperature will begin rising to set temperature. Particularly useful in a

production environment for monitoring of set temperatures, since under most production circumstances the temperature will not deviate.

TEMPERATURE SETBACK - System feature which, when enabled, will independently set back the Set Tip Temperature to 177°C (350°F) after a user selected period of handpiece inactivity (10 to 90 minutes, settable in 10 minute increments). This feature is enabled (or disabled) in the Set-Up Mode.

TIP OFFSET CONSTANT - Specific value for a given handpiece/tip combination upon which the system automatically calculates the correct Tip Temperature Offset at any entered Set Tip Temperature. This value is the temperature loss (Tip Temperature Offset) at 371°C (700°F) and is set in the Set-Up Mode. A value of 0-115°C (0-240°F) may be entered in the Set-Up Mode.

TIP TEMPERATURE OFFSET - Difference in value between the temperature measured by the temperature sensor (at the heater) and the true temperature of the tip at a given Set Tip Temperature.

Packing List

Item #	Description	Part Number	ST 145 Only	ST 145 E Only
1	System Power Supply		1	0
2	System Power Supply (Export)		0	1
5	Power Cord, 115V	1332-0094	1	0
6	Power Cord, 230V	1332-0093	0	1
7	Tip Tool	1100-0206	0	0
8	Hex Key, .050	1100-0237	1	1
9	Hot Grip Removal Pad	1100-0307	0	0
10	Operations Manual CD	CD5050-0459	1	1

Spare Parts

Item #	Description	PACE Part Number
1	Fuse, 1.25 Amp, 250 V, Time Lag (ST 145)	1159-0251-P5
	Fuse, 0.63 Amp, 250 V, Time Lag (ST 145E)	1159-0252-P5
2	TEKLINK Cable	1332-0252-P1
3	TEKLINK Remote Box	3008-0218-P1
4	Tip & Temperature Selection Chart	5050-0251

Service

Please contact PACE or your local distributor for service and repair.

“SODRTEK by PACE” LIMITED WARRANTY STATEMENT

Limited Warranty

Seller warrants to the first user that products manufactured by it and supplied hereunder are free of defects in materials and workmanship for a period of one (1) year from the date of receipt by such user. Monitors, computers and other brand equipment supplied but not manufactured by PACE are covered under their respective manufacturer's warranty in lieu of this Warranty.

This warranty does not cover wear and tear under normal use, repair or replacement required as a result of misuse, improper application, mishandling or improper storage. Consumable items such as tips, heaters, filters, etc. which wear out under normal use are excluded. Failure to perform recommended routine maintenance, alterations or repairs made other than in accordance with Seller's directions, or removal or alteration of identification markings in any way will void this warranty. This warranty is available only to the first user, but the exclusions and limitations herein apply to all persons and entities.

SELLER MAKES NO OTHER WARRANTY, EXPRESS OR IMPLIED, AND MAKES NO WARRANTY OF MERCHANTABILITY OR FITNESS FOR A PARTICULAR PURPOSE.

Seller will, at its option, repair or replace any defective products at its facility or other location approved by it at no charge to user, or provide parts without charge for installation by the user in the field at user's expense and risk. User will be responsible for all costs of shipping equipment to Seller or other location for warranty service.

EXCEPT FOR THE REMEDY ABOVE DESCRIBED, UNLESS OTHERWISE REQUIRED BY APPLICABLE LAW, SELLER WILL HAVE NO OTHER OBLIGATION WITH REGARD TO ANY BREACH OF WARRANTY OR OTHER CLAIM WITH RESPECT TO THE PRODUCTS, OR LIABILITY FOR ANY DIRECT, INDIRECT, CONSEQUENTIAL, OR INCIDENTAL LOSS OR DAMAGE CAUSED BY OR OCCURRING IN CONNECTION WITH ANY OF THE PRODUCTS.

Warranty service may be obtained by contacting the appropriate PACE Company or local Authorized PACE distributor as set forth below to determine if return of any item is required, or if repairs can be made by the user in the field. Any warranty or other claim with respect to the products must be made with sufficient evidence of purchase and date of receipt, otherwise user's rights under this warranty shall be deemed waived.

For PACE USA Customers:

PACE, INCORPORATED
9030 Junction Drive
Annapolis Junction, Maryland 20701
Tel. 301-317-3588
FAX: 301-498-3252

For PACE EUROPE Customers:

PACE EUROPE LIMITED
Sherbourne House, Sherbourne Drive,
Tilbrook, Milton Keynes
MK7 8HX
United Kingdom
Tel. (44) 1908 277666
WARRANTY SERVICE FAX: (44) 1908 277 777

All other Customers:

Local Authorized PACE Distributor

PACE Incorporated retains the right to make changes to specifications contained herein at any time, without notice. Contact your local authorized PACE Distributor or PACE Incorporated to obtain the latest specifications.

The following are trademarks and/or service marks of PACE, Incorporated, MD, USA:

INSTACAL™, FUMEFLO™, HEATWISE™, PACEWORLDWIDE™, PERMAGROUND™, POWERPORT™, POWERMODULE™, TEMPWISE™, TIP-BRITE™, AUTO-OFF™, and TEKLINK™.

The following are registered trademarks and/or service marks of PACE Incorporated, Annapolis Junction Maryland U.S.A.

ARM-EVAC®, FLO-D-SODR®, MINIWAVE®, PACE®, SENSATEMP®, SNAP-VAC®, SODRTEK®, SODR-X-TRACTOR®, THERMOFLO®, THERMOJET®, THERMOTWEEZ®, VISIFILTER®, THERMO-DRIVE®, and TOOLNET®.

PACE products meet or exceed all applicable military and civilian EOS/ESD, temperature stability and other specifications including MIL STD 2000, ANSI/JSTD 001, IPC7711, and IPC A-610.



www.paceworldwide.com

PACE USA

9893 Brewers Court
Laurel, MD 20723
USA
MK7 8HX
United Kingdom

Tel: (301) 490-9860
Fax: (301) 498-3252

PACE Europe

Sherbourne House
Sherbourne Drive
Tilbrook, Milton Keynes

(44) 01908-277666
(44) 01908-277777